



NEW
*Decograin surfaces Winchester Oak
and Titan Metallic CH 703*



Sectional Garage Doors

More convenience and security every day







Hörmann brand quality	4
Advantages of sectional doors	6
Good reasons to try Hörmann	8
Double-skinned steel sectional door LPU	16
Single-skinned steel sectional door LTE	18
Solid timber sectional door LTH	19
Overview of steel sectional doors	20
Overview of solid timber sectional doors	22
S-ribbed	24
M-ribbed	28
L-ribbed	32
L-ribbed with design elements	36
Panelled	38
Aluminium sectional doors ALR F42	42
Design solid timber doors	44
Colours, Decograin surface finishes, types of solid timber	46
Door handles, glazings	50
Wicket doors	52
Side doors	54
Modernisation solutions	56
Garage door operators	62
Accessories	66
Performance characteristics	70
Dimensions and fitting data	74
Hörmann product range	82

Some of the doors shown are equipped with optional extras and do not always correspond to our standard models.

The surface finishes and colours shown are subject to the limitations of the printing process and cannot be regarded as binding.

All rights reserved. No part may be reproduced without our prior permission. Subject to changes.

Left figure: M-ribbed with Decograin Golden Oak surface finish, Hörmann aluminium entrance door ThermoSafe style 565 in the preferred colour Anthracite grey, RAL 7016 with DesignPlus handle, with optional side elements

Hörmann brand quality

Reliable and oriented towards the future



“A good reputation must be earned.” (August Hörmann)

In line with the founder’s philosophy, the Hörmann brand today is a true promise of quality. The family-owned company has over 75 years of experience in door and operator construction and, with sales of over 20 million doors, is no. 1 in Europe. This makes a Hörmann sectional door a reassuring purchase.



Brand quality “Made in Germany”

All doors and operator components developed and manufactured by Hörmann are perfectly matched to each other and tested and certified by independent, recognised institutes to ensure your safety. They are manufactured in Germany according to the DIN EN 9001 quality management system and meet the requirements of European standard 13241-1. Furthermore, our highly qualified employees work intensively on new products, continual further developments and improvements to details. Patents and unique products on the market are the result of this.



Garage doors for generations

Endurance tests under real-life conditions ensure mature series products with Hörmann quality. Thanks to this, as well as excellent technical solutions and uncompromising quality assurance, you receive a 10-year warranty on all Hörmann sectional doors and a 5-year warranty on Hörmann operators.*



An eye on the future

Hörmann is setting a good example. This is why, since 2013, the company has obtained 40 % of its required energy from green sources and will continue to increase this percentage. At the same time, many tonnes of CO₂ are saved each year thanks to the introduction of an intelligent and certified energy management system. And last but not least, Hörmann also offers products for sustainable construction. Find out more about Hörmann’s environmental activities in the “We think green” brochure.

* The complete warranty conditions can be found at: www.hoermann.com

Benefit from numerous advantages

Sectional doors always fit and save space



Sectional doors open vertically upwards and are suspended under the ceiling to save space. This construction principle means you can make full use of the space inside and in front of the garage. Additionally, sectional garage doors can be fitted in every garage door opening, offer a wider passage width and are optimally sealed.

Treat yourself to this comfort and convenience.



Easier entrance into the garage and more room in front of and in the garage



For every fitting situation

The shape of the garage door opening is not of prime importance. Whether square, angled, with segmental or full centred arch – a sectional door always fits.



Narrow passage width
with old up-and-over doors



Complete passage width
with modern sectional doors

Wider passage

With older up-and-over doors, driving in and out is often a matter of millimetres. Sectional doors with a passage width extended by up to 14 cm also make it much easier to park modern, larger vehicles and SUVs.



Sealed all-round

Flexible and weather-resistant seals on all four sides of Hörmann's sectional doors keep out the wind, rain and snow. High-quality intermediate seals between the door sections of double-skinned doors provide for additional sealing. Thanks to its large-sized profile lip, the bottom seal can easily accommodate slight irregularities in the floor. Optional bottom seals with ventilation slots or ventilation grilles in a door section ensure sufficient ventilation.

Good reasons to try Hörmann

High production quality down to the last detail



1

A harmonious overall appearance

[1] Even spacing and invisible section transitions for ribbed doors

Hörmann garage doors are distinguished by even, exact spacing of sections [A]. The sections are shaped so that the transitions are practically invisible when the door is closed. See for yourself!

To add to the overall appearance, a practical side door with an alignment matching the sectional garage doors is also available (see page 54).

[2] Irregular spacing of sections [B], [C] due to different section heights coupled with visible section transitions on competitor doors. This gives the door an uneven look.

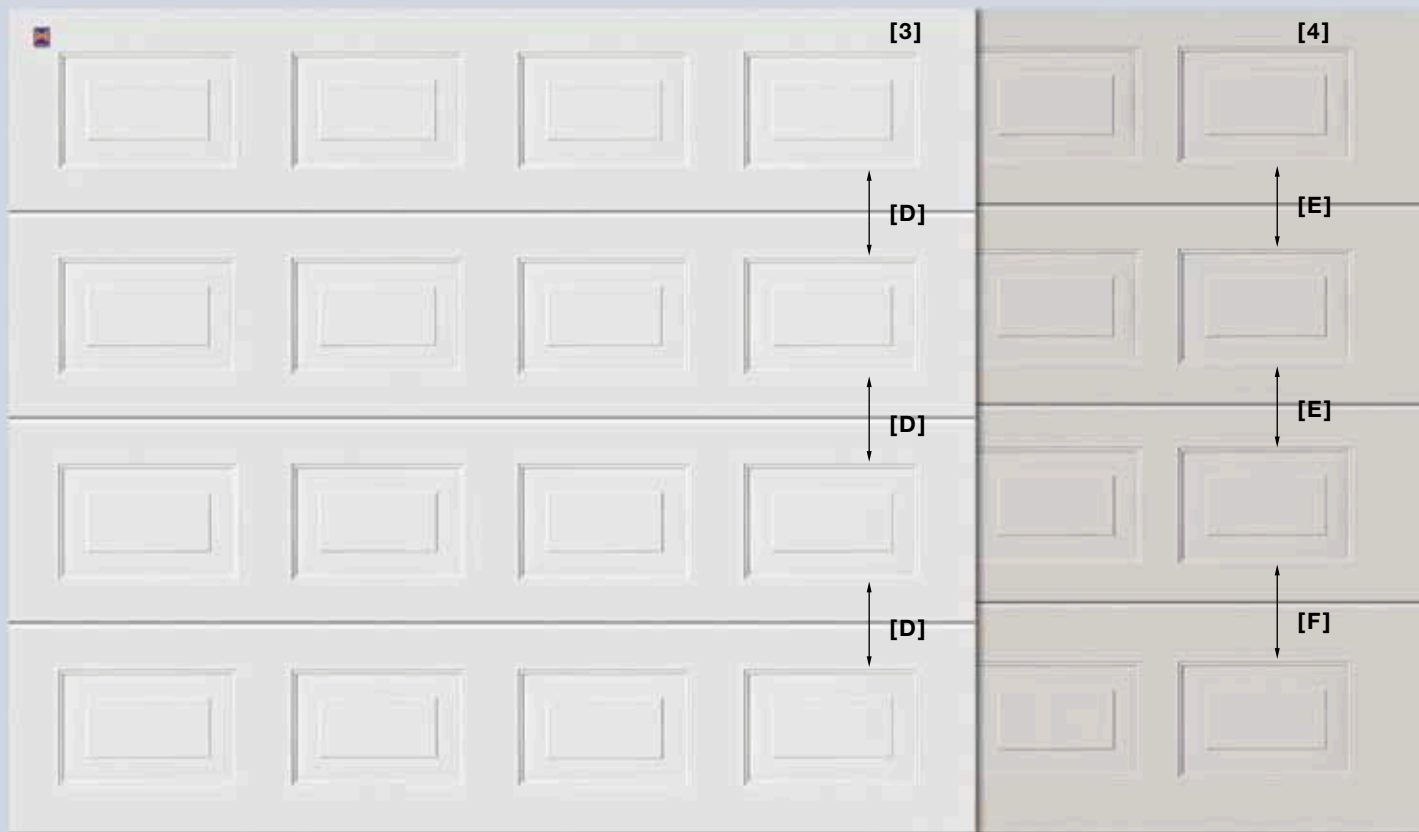

[3] Uniformly divided panelled doors

To create a harmonious overall appearance, the height of the spaces between the individual panels [D] of Hörmann sectional doors is exactly even. This is achieved by using sections with the same height across the entire door height. The horizontal spacing between the panels within a section is also uniform. This gives the doors an even appearance.

On request, side doors are also available with the same section spacing as the sectional garage door (see page 54).

[4] Irregular panel spacing [E], [F] due to different section heights on competitor doors. This gives the door an uneven look.

Good reasons to try Hörmann

Perfect appearance

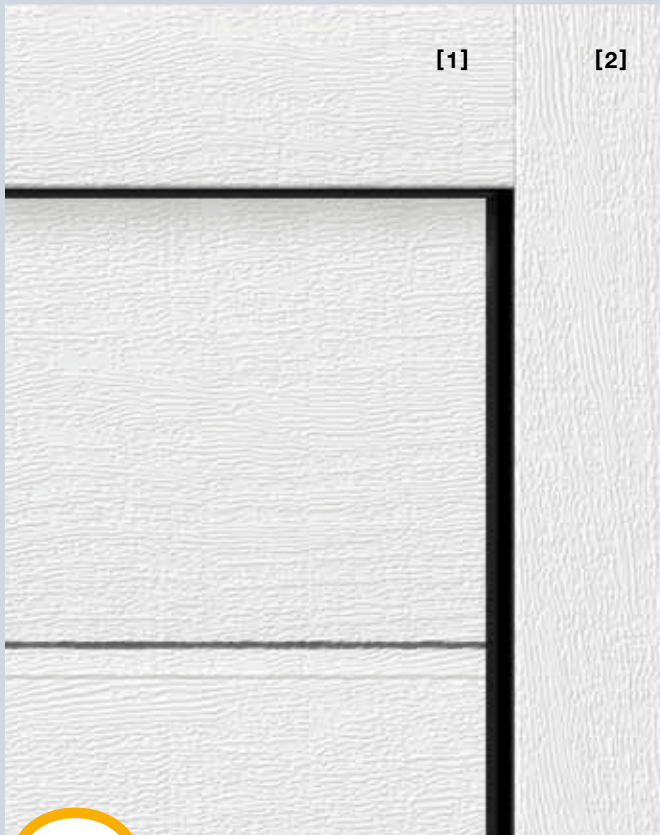

2

Matching appearance of frames and door leaves

A harmonious overall appearance for all surface finishes

The perfect appearance of a door is the result of many small details: For white doors and all surface finishes, the fascia panel [1] is always provided matching the door sections. This ensures that everything fits together. The side frames [2] are available with a white Woodgrain surface finish as standard. For sectional doors with the surface finishes Sandgrain, Silkgrain or Decograin, the frame coverings are optionally available in the surface finish of the door section. For Micrograin doors, the frame covering is provided with a smooth surface finish.

Matching appearance of coloured and Decograin doors

Frame coverings in the same colour or style as the door section

Coloured sectional doors and doors with Decograin surface finishes are also optionally available with frame coverings [2] that match the surface finish and colour or the style of the door sections. The fascia panels [1] for these doors always match the surface finish and colour or style of the door section.

For further information, please see pages 59 – 60.



3

Flush-fitting fascia panels

Flush-fitting fascia panels

For LPU doors, a fascia panel is the most elegant solution for an invisible transition between the panel and door leaf. When the door is closed, the top door section is flush with the panel.

For further information, please see page 59.

4

Detailed Decograin surface finishes

6 Decograin decors

The UV-resistant synthetic foil coating on the exterior of the steel panels has all the aesthetics of timber or an elegant metallic appearance in Anthracite.

A special surface protection preserves the appearance of the door over a long time.

For further information, please see page 48.

Good reasons to try Hörmann

Innovations from the market leader



5

Optimum long-term protection

Also resistant to waterlogging

A non-brittle, 4 cm plastic frame shoe offers long-term protection against corrosion (even with waterlogging) that is unmatched by competitor solutions. The frame shoe completely covers the frame in the area susceptible to rust. Only this offers true long-term protection. Together with the door's bottom seal, the frame shoe makes for a bottom edge that is visually appealing.



6

Efficient thermal insulation

With thermal break between the frame and the building structure.

A well-insulated garage door is always recommended when the garage and the home are directly connected. To further improve the already high insulation values, especially of its LPU sectional door, Hörmann has developed the ThermoFrame frame connection, a plastic profile that can be simply fitted together with the door frame.

This creates a thermal break between the frame and the brickwork, improving thermal insulation by up to 15%*. The optional ThermoFrame frame connection is available for all Hörmann sectional doors.

* For a double-skinned sectional garage door LPU size 5000 x 2125 mm

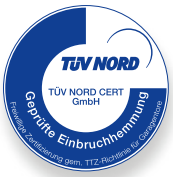

Tested safety

Hörmann automatic sectional doors have been tested and certified by TÜV in accordance with the TTZ directive "Break-in resistance for garage doors". Doors with wicket doors and doors with glazing are an exception.



! Only from Hörmann



! Only from Hörmann

7

Practical solutions

Wicket door with trip-free threshold

Wicket doors are recommended for easy passage into your garage. You can also retrieve bicycles or gardening equipment from your garage without opening the door.

The stainless steel threshold is only 10 mm in the centre and 5 mm high at the sides. This makes it easier to wheel things through and reduces the risk of tripping up.

8

More security, of course

Reliable protection with the anti-lift kit

Uninvited guests barely stand a chance with Hörmann's automatic sectional doors. When the garage door is closed, the anti-lift kit automatically engages in the operator boom's stop, then locks immediately and is secured against forced opening. This door latching functions purely mechanically, and in contrast to competitor operators, continues to secure the door even when the power fails.



Take a look at the video at: www.hoermann.com/en/videos



Good reasons to try Hörmann

Hörmann BiSecur: The modern radio system for garage door and entrance gate operators



Bi-directional radio system BiSecur

9

Convenient querying of the door position

The modern radio system for garage door and entrance gate operators

Our bi-directional, high-security BiSecur radio system is based on future-oriented technology that allows you to conveniently and safely operate garage doors, entrance gates, lights and much more.



Take a look at the video at:
www.hoermann.com/en/videos



Convenient and safe

You no longer have to go out in all kinds of weather to check that your garage door is closed. With a single push of a button, the LED colour on the hand transmitter HS 5 BS shows you whether the door is open or closed. If required, another push of a button* closes the door.

BiSecur Gateway and smartphone app **// NEW**

With the app and Hörmann gateway, you can conveniently control your Hörmann garage door or entrance gate operators, Hörmann entrance door** and other devices using your smartphone or tablet.

* An additional photocell is required for operation without visual contact to the door.

** With special equipment



Patent pending



10

Certified security

11

Award-winning design

With a stable, interference-free range

The newly developed, extremely secure BiSecur encryption protocol makes sure that no-one can copy your radio signal. Tested and certified by security experts at the Bochum University and as safe as online banking.

Exclusive hand transmitters

In addition to a black or white design, BiSecur hand transmitters are characterised by an elegant shape that fits easily in the palm of your hand.

Hörmann's BiSecur hand transmitter with an optional high-gloss surface in a piano lacquer look received an award for its exclusive design from an international jury.



Take a look at the video at: www.hoermann.com/en/videos



Figure above: HS 5 BS hand transmitter with hand transmitter station (optional).

Double-skinned steel sectional door LPU

Highest thermal insulation and greatest variety of surface finishes

LPU

Double-skinned LPU doors offer the best-possible insulation. Moreover, the 42-mm-thick sections give the door the greatest stability and make for quiet operation.



Woodgrain



Traffic white RAL 9016



15 preferred colours



RAL to choose

On this inexpensive, robust surface with an authentic sawn timber look, minor scratches can be easily repaired by working with the texture.

Door styles

S-ribbed
M-ribbed
Panelled

Sandgrain // **NEW**

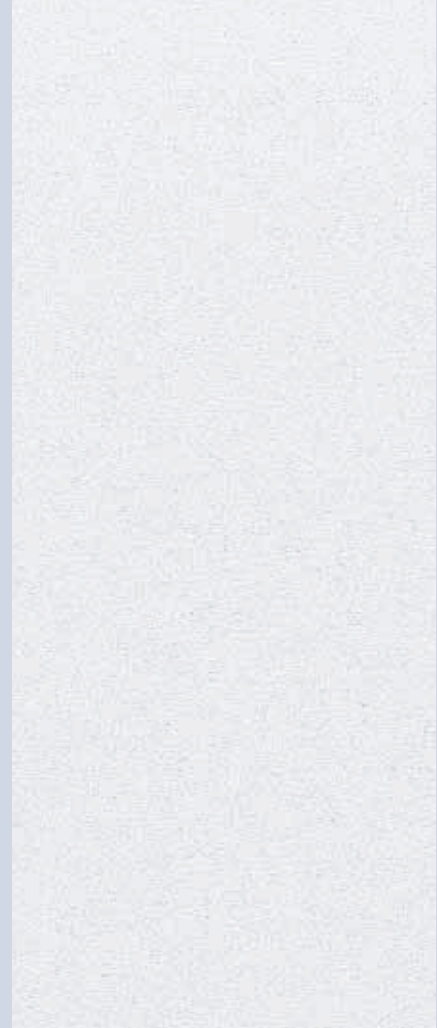

Traffic white RAL 9016



3 preferred colours

This finely structured surface is an ideal choice for price-conscious owners and is particularly suited for modern homes.

Door styles

M-ribbed
L-ribbed



**50 % thicker exterior sheet
for Silkgrain surface finishes**

Micrograin

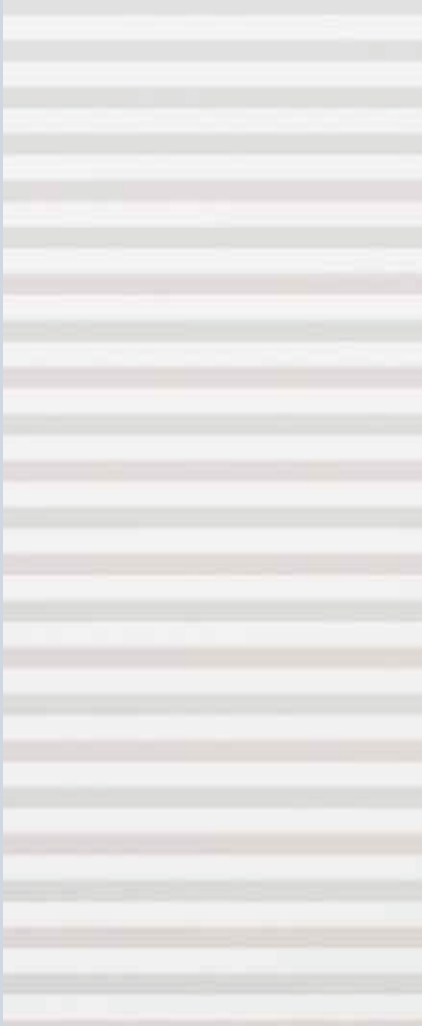

Traffic white RAL 9016



15 preferred colours



RAL to choose

This surface features a wave profile that is embossed into smooth steel, producing attractive light and shadow effects.

Door styles

- M-ribbed
- L-ribbed

Silkgrain *// NEW*

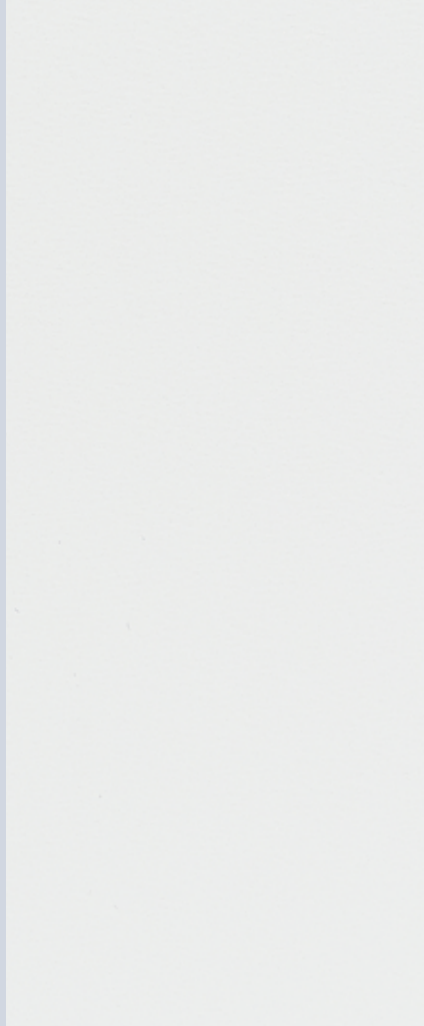

Traffic white RAL 9016

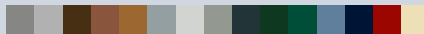

15 preferred colours



RAL to choose

Thanks to its elegant door appearance, the silky smooth Silkgrain surface finish is the first choice for modern architecture. A 50 % thicker exterior sheet on the sections also ensures higher stability and even smoother running.

Door styles

- M-ribbed
- L-ribbed
- L-ribbed with design elements

Decograin decors



Golden Oak

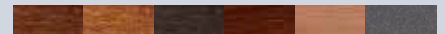

6 decors

Decograin surface finishes with UV-resistant plastic film coating give your sectional door a striking and authentic timber look or an elegant metallic appearance in Anthracite.

Door styles

- M-ribbed
- L-ribbed *// NEW*
- Panelled*

* not available in Titan Metallic CH 703

Single-skinned steel sectional door LTE

Affordable variation with a heavy-duty surface finish

LTE

Single-skinned LTE doors are the ideal solution for detached garages that do not require additional thermal insulation.

Woodgrain



Traffic white RAL 9016

On this inexpensive, robust surface with an authentic sawn timber look, minor scratches can be easily repaired by working with the texture.

Door styles

- S-ribbed
- M-ribbed
- Panelled

Solid timber sectional door LTH

Natural section design in 2 types of timber

LTH

Doors made of solid timber panels are excellently suited for timber houses or buildings with many timber elements, such as timber framing or facade elements.

The timber is impregnated at the factory to protect it against insect and fungal attack. To protect it from weathering and retain its beautiful appearance, please treat the timber with a wood preservative.



Nordic Pine



impregnated

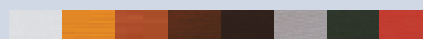

8 types of wood preservative

Nordic Pine is a light-coloured softwood with predominantly straight graining. Heart shakes, individual resin pockets, spiral graining and the yellowish brown “knots” are natural characteristics of the wood.

Door styles

S-ribbed
M-ribbed
L-ribbed
Panelled
Design styles

Hemlock



impregnated

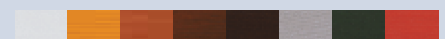

8 types of wood preservative

Hemlock is a greyish white to light-greyish brown softwood with predominantly straight grain, brown mineral stripes along the grain with bark pockets.

Door styles

S-ribbed
M-ribbed
L-ribbed
Panelled
Design styles

Overview of steel sectional doors

Styles and dimensions



Single-skinned steel sectional door LTE

S-ribbed

Width 5000 mm

Height 3000 mm

M-ribbed

Width 3000 mm

Height 3000 mm

Panelled

Width 3000 mm

Height 3000 mm



Double-skinned steel sectional door LPU

S-ribbed

Width 6000 (7000*) mm

Height 3000 (5000*) mm

* SPU F42 Plus

M-ribbed

Width 6000 (7000*) mm

Height 3000 (5000*) mm

* SPU F42 Plus

L-ribbed

Width 6000 (7000*) mm

Height 3000 (5000*) mm

* SPU F42 Plus

Panelled

Width 5500 mm

Height 3000 mm

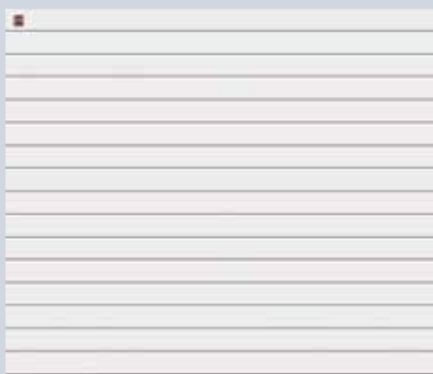

S-ribbed, Traffic white, RAL 9016

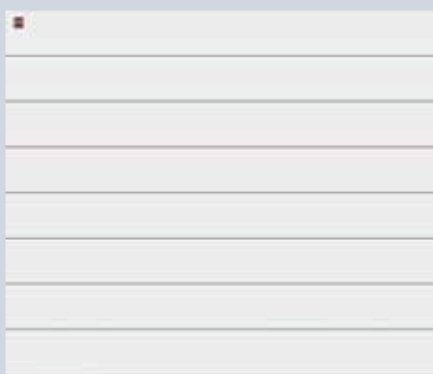

M-ribbed, Traffic white, RAL 9016



L-ribbed, Traffic white, RAL 9016



Panel, Traffic white, RAL 9016

Overview of L-ribbed doors with design elements

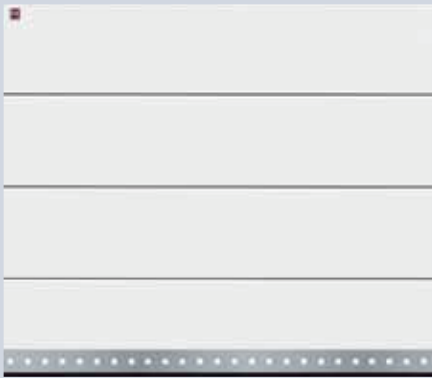

Style 450, Traffic white, RAL 9016



Style 456, Traffic white, RAL 9016



Style 461 with glazing, Traffic white RAL 9016
Style 451 without glazing (not shown)

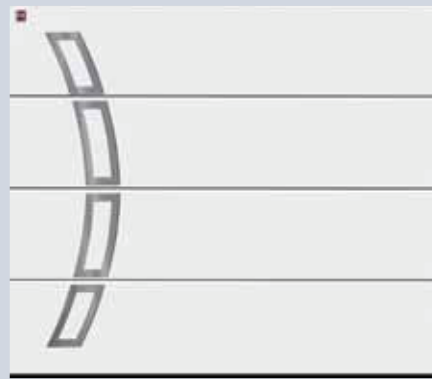

Style 457, arranged to the left, mirrored design, Traffic white RAL 9016



Style 462 with glazing, Traffic white RAL 9016
Style 452 without glazing (not shown)



Style 458, Traffic white, RAL 9016



Style 454, design arranged in the centre, Traffic white, RAL 9016

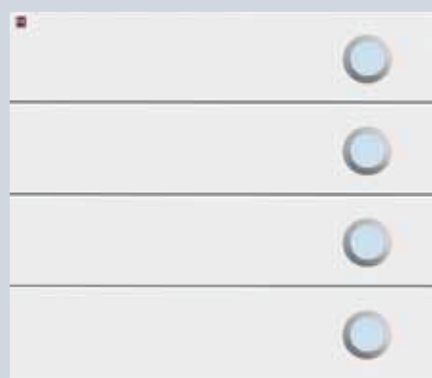

Style 469 with glazing, Traffic white RAL 9016
Style 459 without glazing (not shown)

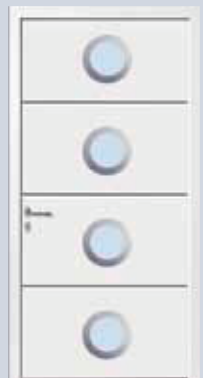

Overview of solid timber sectional doors

Styles and dimensions



Solid timber sectional door LTH

S-ribbed

Width 5000 mm

Height 3000 mm

M-ribbed

Width 5000 mm

Height 3000 mm

L-ribbed

Width 5000 mm

Height 3000 mm

Panelled

Width 5000 mm

Height 3000 mm

Design

Width 5000 mm

Height 3000 mm



S-ribbed, Nordic Pine



M-ribbed, Nordic Pine



L-ribbed, Nordic Pine



Panelled, Nordic Pine

Design styles overview



Style 401, Nordic Pine



Style 402, Nordic Pine



Style 403, Nordic Pine



Style 403 with natural stone, Nordic Pine



Style 404, Nordic Pine



Style 404 with natural stone, Nordic Pine

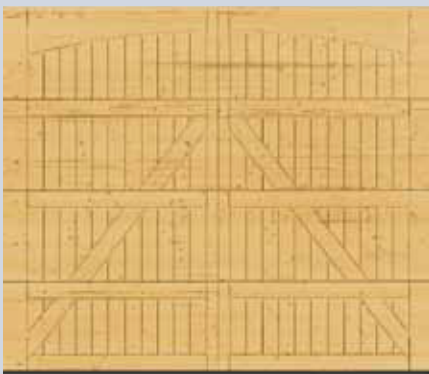

Style 405, without optional hinged door fittings "Standard", Nordic Pine

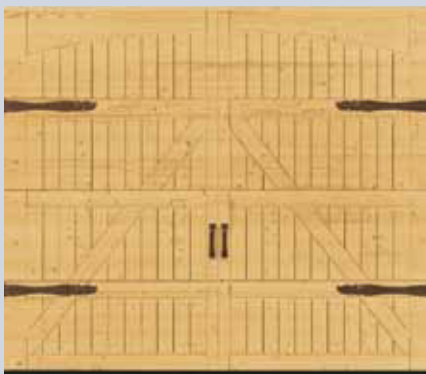

Style 405, with optional hinged door fittings "Exclusive", Nordic Pine

Individual designs

Design your own timber door: A simple drawing is enough for us to manufacture an individual door for you using a computer-aided mill.

Setting accents

Choose from 3 natural stones. In styles 403 and 404, natural stone is used as an attractive design feature. Variations in colour and structure are a natural characteristic.



Tropical-green



Multicolour-red



Balmoral-rosso

On request, each garage door can be supplied with a matching side door.

S-ribbed

Door style with a classic look



Hörmann aluminium entrance door ThermoSafe, style 860 in the preferred colour Anthracite grey, RAL 7016



S-ribbed with the surface finish Woodgrain in the preferred colour Anthracite grey, RAL 7016

S-ribbed

With steel or solid timber panels



S-ribbed with the surface finish Woodgrain in the preferred colour Fir green, RAL 6009



S-ribbed with the surface finish Woodgrain in the preferred colour Anthracite grey, RAL 7016



S-ribbed in Hemlock



Brief overview



**Single-skinned
steel sectional door
LTE**

Woodgrain

Traffic white RAL 9016

Max. dimensions

Width 5000 mm

Height 3000 mm



**Double-skinned
steel sectional door
LPU**

Woodgrain

Traffic white RAL 9016

15 preferred colours

RAL to choose

Max. dimensions

Width 6000 (7000*) mm

Height 3000 (5000*) mm

* SPU F42 Plus



**Solid timber
sectional door
LTH**

Nordic Pine

impregnated

8 types of wood preservative

Hemlock

impregnated

8 types of wood preservative

Max. dimensions

Width 5000 mm

Height 3000 mm



S-ribbed with the surface finish Woodgrain in Traffic white, RAL 9016 with matching side door (see pages 54 – 55)

Colours and designs

From page 47

Dimensions and fitting data

From page 74

M-ribbed

The door style for modern architecture



Hörmann aluminium entrance door ThermoSafe, style 845 in the preferred colour Window grey, RAL 7040



M-ribbed with the surface finish Decograin Rosewood

M-ribbed

Steel or solid timber panels



M-ribbed in Hemlock, impregnated at the factory



M-ribbed with Silkgrain surface finish in Traffic white, RAL 9016, with LED light strip on the lintel

M-ribbed with the surface finish Decograin Titan Metallic CH 703



Brief overview



M-ribbed with the surface finish Woodgrain in the preferred colour Anthracite grey, RAL 7016 with a practical wicket door with trip-free threshold (see page 52)



Single-skinned steel sectional door
LTE

Woodgrain

Traffic white RAL 9016

Max. dimensions

Width 3000 mm

Height 3000 mm



Double-skinned steel sectional door
LPU

Woodgrain

Traffic white RAL 9016

15 preferred colours

RAL to choose

Sandgrain // NEW

Traffic white RAL 9016

3 preferred colours

Micrograin

Traffic white RAL 9016

15 preferred colours

RAL to choose

Silkgrain // NEW

Traffic white RAL 9016

15 preferred colours

RAL to choose

Decograin

Golden Oak, Dark Oak, Night Oak, Winchester Oak, Titan Metallic CH 703

Max. dimensions

Width 6000 (7000*) mm

Height 3000 (5000*) mm

* SPU F42 Plus



Solid timber sectional door
LTH

Nordic Pine

impregnated

8 types of wood preservative

Hemlock

impregnated

8 types of wood preservative

Max. dimensions

Width 5000 mm

Height 3000 mm

Colours and designs

From page 47

Dimensions and fitting data

From page 74



L-ribbed

The door style with superior elegance





L-ribbed with the surface finish Decograin Titan Metallic CH 703

L-ribbed

Steel or solid timber panels



L-ribbed with the surface finish Silkgrain in the preferred colour Ochre brown, RAL 8001



L-ribbed in Nordic Pine

L-ribbed with the surface finish Silkgrain in the preferred colour Light grey, RAL 7035 and aluminium entrance door ThermoSafe style 686



Brief overview



L-ribbed with the surface finish Decograin Winchester Oak **// NEW**



**Double-skinned
steel sectional door
LPU**

Sandgrain // NEW

Traffic white RAL 9016
3 preferred colours

Micrograin

Traffic white RAL 9016
15 preferred colours
RAL to choose

Silkgrain // NEW

Traffic white RAL 9016
15 preferred colours
RAL to choose

Decograin

Golden Oak, Dark Oak, Night Oak,
Rosewood, Winchester Oak,
Titan Metallic CH 703

Max. dimensions

Width 6000 (7000*) mm
Height 3000 (5000*) mm
* SPU F42 Plus



**Solid timber
sectional door
LTH**

Nordic Pine

impregnated
8 types of wood preservative

Hemlock

impregnated
8 types of wood preservative

Max. dimensions

Width 5000 mm
Height 3000 mm

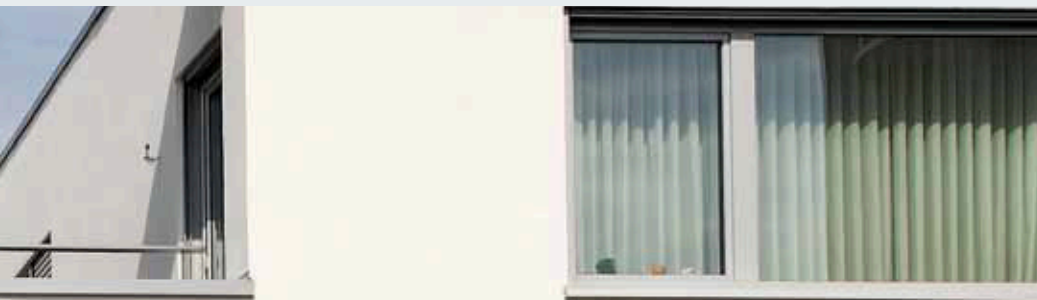

Colours and designs

From page 47

Dimensions and fitting data

From page 74

L-ribbed with design elements

With stainless steel embellishments and glazing elements



Design L-ribbed style 461 with glazing elements in the preferred colour Ruby red, RAL 3003
Hörmann aluminium entrance door ThermoSafe style173



Design L-ribbed style 450
in the preferred colour Light grey, RAL 7035
Hörmann aluminium entrance door ThermoSafe style 693



L-ribbed design style 457 in Traffic white, RAL 9016
Hörmann entrance door ThermoSafe style 188



Garage and entrance doors in matching styles

Brief overview



**Double-skinned
steel sectional door
LPU**

Sandgrain // NEW

Traffic white RAL 9016
3 preferred colours

Silkgrain // NEW

Traffic white RAL 9016
15 preferred colours
RAL to choose

Max. dimensions

Width 6000 (7000*) mm

Height 3000 (5000*) mm

* SPU F42 Plus

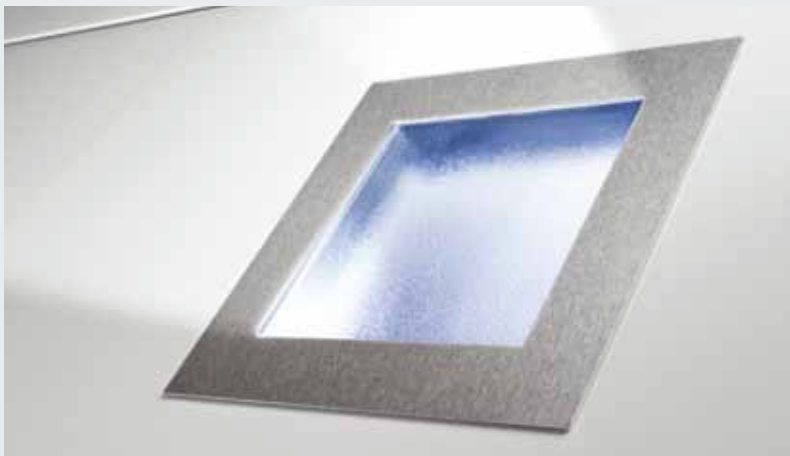

Design elements made of stainless steel or glass



More information can be found
in the brochures Aluminium Entrance Doors
and ThermoPro Entrance Doors.

Colours and designs

From page 47

Dimensions and fitting data

From page 74

Panelled

The door style for classic buildings





Panelled with the surface finish Woodgrain in the preferred colour Anthracite grey, RAL 7016

Panelled

Steel or solid timber panels



Panelled in Hemlock



Panelled with the surface finish Woodgrain in Traffic white, RAL 9016

Panelled with the surface finish Decograin Golden Oak



Brief overview



Panelled in Hemlock, wood preservative in Limestone white



Single-skinned steel sectional door
LTE

Woodgrain

Traffic white RAL 9016

Max. dimensions

Width 3000 mm

Height 3000 mm



Double-skinned steel sectional door
LPU

Woodgrain

Traffic white RAL 9016

15 preferred colours

RAL to choose

Decograin

Golden Oak, Dark Oak, Night Oak, Rosewood, Winchester Oak, Titan Metallic CH 703

Max. dimensions

Width 5500 mm

Height 3000 mm



Solid timber sectional door
LTH

Nordic Pine

impregnated

8 types of wood preservative

Hemlock

impregnated

8 types of wood preservative

Max. dimensions

Width 5000 mm

Height 3000 mm



Colours and designs

From page 47

Dimensions and fitting data

From page 74

Aluminium sectional doors ALR F42

For individual designs on site



Aluminium sectional door ALR F42 with on-site cladding



Aluminium sectional door ALR F42 with on-site cladding



ALR F42 **For exclusive** **facade designs**

With the aluminium sectional door, your garage door is seamlessly integrated into the overall design of your home.

The door basis for facade cladding is a Hörmann industrial sectional door ALR F42 with an aluminium frame construction and PU sandwich infill.

You can design the on-site, flush-fitting cladding according to your wishes with timber, metal, ceramic, plastic and many additional materials. Please consult with your local Hörmann specialised dealer.



You can find detailed technical manuals at

[www.hormann.co.uk/
documentation/
technical-manual](http://www.hormann.co.uk/documentation/technical-manual)



Aluminium sectional door ALR F42 Vitraplan

ALR F42 Vitraplan

The door is especially elegant thanks to offset, flush-fitting glazing. The frame profile is concealed, so nothing detracts from the overall appearance. This exclusive door fascinates with a mix of mirroring and transparency.

Detailed information can be found in the Industrial sectional garage door brochure.

Design solid timber doors

Rustic door styles or individual designs



Brief overview



Solid timber sectional door LTH

Nordic Pine
impregnated
8 types of wood preservative

Hemlock
impregnated
8 types of wood preservative



Door style 403 in Nordic Pine with tropical green natural stone



An example of individual milling, painted white on-site



Individual designs

For example, displaying your initials, house number or your favourite motif. Just provide us with an appropriate drawing and we will create a personal garage door for you. It will be an enviable original.



Door style 402 in Nordic Pine with a matching side door

Left figure: door style 405, painted white on-site with hinged door fitting kit and decorative handles

Colours and designs

From page 49

Dimensions and fitting data

From page 74

Colours, decor surface finishes and solid timber panels

It's your choice



15 equally-priced preferred colours

Double-skinned LPU sectional doors and side doors are available as standard in Traffic white, RAL 9016, as well as in 15 inexpensive preferred colours and in around 200 colours from the RAL colour chart*. You can choose from 3 preferred colours** for the new surface finish Sandgrain. Single-skinned LTE doors are only available in Traffic white.

The surfaces are perfectly protected against rust. Rain runs off without leaving any streaky marks thanks to the use of hot-galvanized material and a high-quality polyester-primer coating on both sides. A grey haze from air pollution is largely prevented.

Decograin surface finishes

(see page 48)

Decograin is available in five natural-looking timber designs and with an anthracite metallic effect. An embossed wood grain gives it all the aesthetics of timber. The door remains beautiful for a long time thanks to the special surface protection of the UV-resistant plastic film coating on the outside of the steel sections.

Solid timber surface finishes

(see page 49)

Nordic Pine is a light-coloured softwood with predominantly straight graining. Heart shakes, individual resin pockets, spiral graining and the yellowish brown “knots” are natural characteristics of the wood.

Hemlock is a greyish white to light-greyish brown softwood with predominantly straight grain, brown mineral stripes along the grain with bark pockets.

The timber is impregnated at the factory to protect it against insect and fungal attack. To protect it from weathering and retain its beautiful appearance, please treat the timber with a wood preservative.

Sectional garage doors are generally supplied in Grey white, RAL 9002 on the inside of the door.

Dark colours should not be used for double-skinned steel doors that are exposed to the sun, as possible section deflection may restrict the door's function.







All colours based on RAL.

The colours and surfaces shown are subject to the limitations of the printing process and cannot be regarded as binding. Please seek the expert advice of your Hörmann specialist dealer.

* With the exception of pearl-effect, fluorescent and metallic colours.

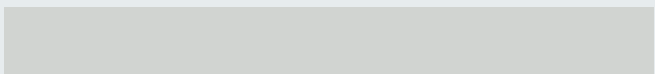
** Preferred colours for Sandgrain surface finish

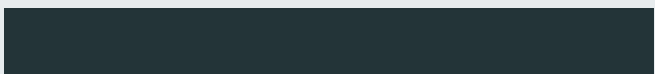
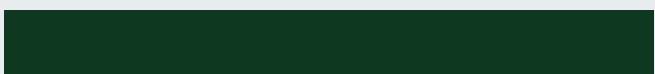
15 preferred colours

	Grey aluminium	RAL 9007
	White aluminium**	RAL 9006
	Terra brown**	RAL 8028
	Clay brown	RAL 8003
	Ochre brown	RAL 8001
	Window grey	RAL 7040
	Light grey	RAL 7035
	Stone grey	RAL 7030
	Anthracite grey**	RAL 7016
	Fir green	RAL 6009
	Moss green	RAL 6005
	Pigeon blue	RAL 5014
	Steel blue	RAL 5011
	Ruby red	RAL 3003
	Light ivory	RAL 1015

Decor surface finishes

6 Decograin surface finishes



Decograin Golden Oak, medium brown, golden yellow oak design



Decograin Dark Oak, walnut-coloured oak design

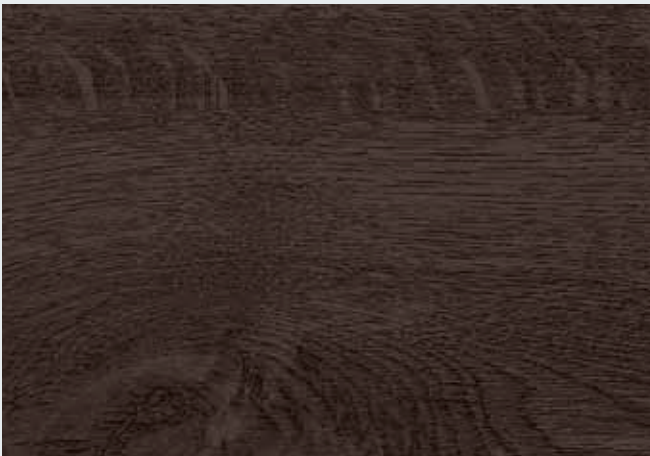

Decograin Night Oak, dark, intense oak design



Decograin Rosewood, mahogany-coloured timber design

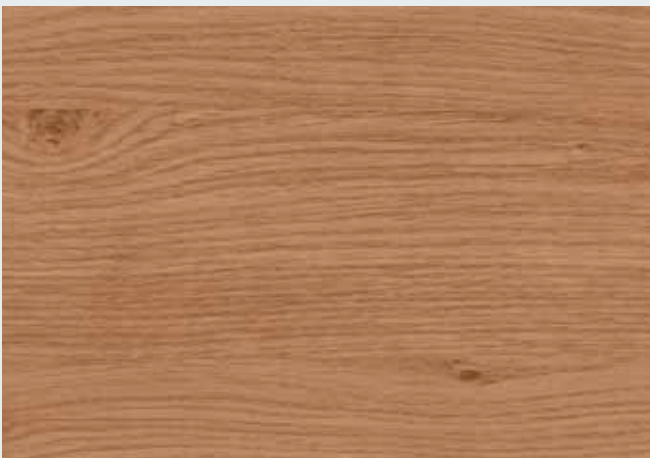

Decograin Winchester Oak: natural-coloured knotty oak design
// NEW from Autumn 2014



Titan Metallic CH 703: anthracite with a metallic effect
// NEW from autumn 2014

Solid timber panels

2 types of solid timber



Nordic Pine, impregnated

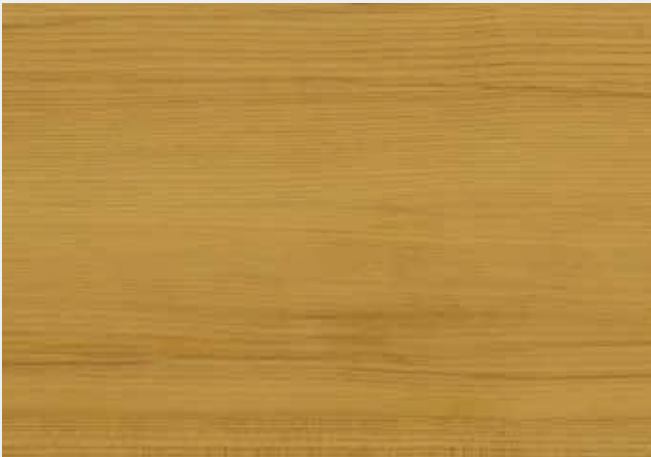

Hemlock, impregnated

Nordic Pine wood preservatives

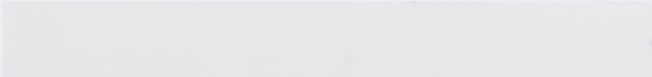

Limestone white



Pine



Teak



Rosewood

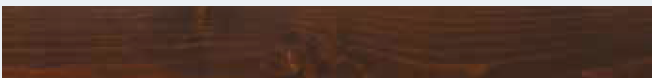

Ebony

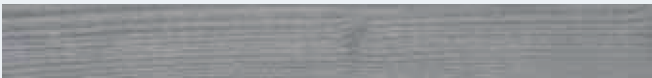

Agate grey



Fir green



Nordic red

Hemlock wood preservatives

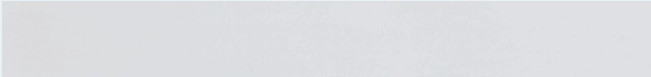

Limestone white



Pine



Teak



Rosewood

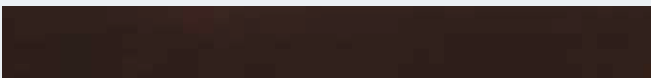

Ebony



Agate grey

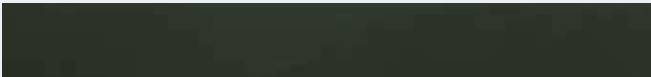

Fir green



Nordic red

Door handles



Polished stainless steel



Black plastic



White cast aluminium, RAL 9016



Silver cast aluminium



Brushed stainless steel



Brown cast aluminium, RAL 8028

The flush-fitting cylinder can also be mastered with other locks in your home.

All colours based on RAL.

More security and better protection against burglars

For garages without a second access door, we offer you the following options to open your automatic garage door from the outside in an emergency (e.g. in the event of a power failure).

Emergency release lock

For automatic sectional doors where no handle is desired, we recommend an emergency release lock with round cylinder (cannot be mastered with other locks in your home).

Door handle including lock

The door handle can be integrated in the master key system. A Bowden cable on the inside unlocks the door.



Emergency release lock



Latch lock

Burglar-proof, manually operated doors

In this lock, a sturdy automatic latching spring disc grips round a solid steel bolt to securely retain the door. Intruders don't stand a chance!

Glazings



Clear synthetic glazing from Hörmann comes as standard with DURATEC glazing.

It offers:

- **Maximum scratch resistance**
- **A permanently clear view**
- **Improved thermal insulation**

Glazing type D

This glazing type is available for all door types and side doors with ribbed design, in all surface finishes. The plastic glazing frame is available in black or white or in door colour on request. Depending on door type, you can choose the glazing with single or double synthetic panes, in a clear version or crystal structure.

Aluminium frames

This version is available for all door types and side doors with ribbed design. The anodised aluminium glazing frame (DIN 17611) in a natural finish E6 / C0 (previously E6 / EV 1) is available on request in door colour. You can choose the glazing with single or double synthetic panes, in a clear version or crystal structure.

Classic glazing

This glazing is available for all door types and side doors with M and L ribbing and panelling.

Sunrise glazing

This variant is available for all door types and side doors with M and L ribbing and panelling. The glazing frame and the decorative rails are available in white plastic as standard or in the colour of the door on request. For Decograin doors the glazing frame and decorative rails are painted in a colour matching the door. Depending on the door type, you can choose the glazing with single or double synthetic panes, in a clear version or crystal structure.

V-panelled glazing

The overall frame dimension is dependent on the panel or door size.

Note:

Glazings not possible in the two bottom door sections.



Glazing type D



Aluminium frames



Classic glazing S0

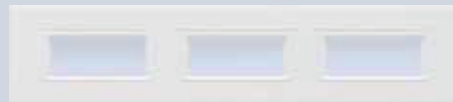

Classic glazing M0



Classic glazing L0



Classic glazing S1



Classic glazing S2



Sunrise glazing S10



Sunrise glazing S60



V-panelled glazing V0

Example of classic glazing in a 2500-mm-wide door.

Your Hörmann partner can show you further Sunrise glazing designs.

Wicket doors with trip-free threshold

A door in the door



Unhindered access to the garage for doors up to 4000 mm width

Only Hörmann offers a wicket door with a stainless steel threshold that is only 10 mm in the centre and 5 mm high at the sides. This reduces the risk of tripping up and makes it easier to wheel things through.

The aluminium door frame is anodised as standard in a natural finish and is also available in the door colour. The top garage door section, also in the wicket door area, comes with a continuous lintel seal.



[1] Overhead door closer
As standard, wicket doors are supplied with slide rail door closers (top figure). An integrated door closer, including hold-open device (fig. on bottom) is optionally available for optimum protection and the best appearance.



[2] Optional multiple-point locking
The wicket door is locked over the entire door height with one bolt and hook bolt per section. The advantage: better stability and improved break-in-resistance.



[3] Robust door catch
This prevents door-leaf drop and buckling.



[4] Concealed hinges
For a uniform look, the wicket doors are equipped with concealed hinges as standard.



A wicket door gives you easy access to everything in the garage: gardening equipment, bicycles or wheelbarrows.



On request, Decograin wicket doors can be supplied with the frame painted to match the colour of the decorative finish.



The panel divisions may vary for panelled doors of the same width, depending on whether or not a wicket door is fitted.



The optional leading photocell VL 2 stops the door without contact. This further increases the safety of your garage door with wicket door and trip-free threshold.



Manually-operated garage doors with a wicket door do not have an outside handle. They are locked from the inside.

Side doors

A matching side door for every garage door



Ready-to-fit door set

Hörmann side doors are supplied ready-to-fit with profile cylinder mortise lock, round handle / lever handle set with oval rose escutcheons and with 3-way adjustable hinges. Door leaf frames are made of weather-proof aluminium extrusions (depth 60 mm) with all-round seals.

Garage side doors

Versions:

Aluminium block frame
Aluminium corner frame



Narrow surround



Broad surround



Lever handle set

Choose between the standard plastic lever handle or optional lever handle or lever/knob handle set in many materials (Fig: stainless steel lever handle set).



Matching

Decograin side doors come with identical surface finishing for the frame, subframe and door to create a matching appearance.

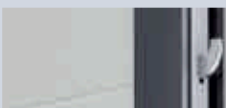

Break-in-resistant

3-point locking as optional equipment for profile type 2 with latch, bolt, 2 locking hooks and security rose escutcheon class 2 according to DIN V ENV 1627-1630.

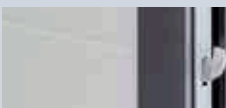

For further information, please see pages 82 / 83 of the fitting data or contact your Hörmann partner.

Double-leaf garage side door

Versions:

Aluminium block frame



Broad surround, opening outwards

Insulated version

Also available with a frame profile with thermal break as TopComfort NT80-2.



The alternative side door – multi-purpose door MZ Thermo

External door with thermal break and the best thermal insulation values

- MZ Thermo with a U-value = 1.2 W/(m²·K)
- Optionally available in a RC 2 KSI Thermo version

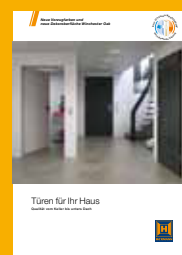

More information can be found in the Doors for Your Home brochure.

Modernise and improve

Hörmann offers premium solutions for every fitting and renovation situation



At some point it is simply time to modernise your garage door. The best partner for this: Hörmann and its inexpensive standard sizes, especially for modernisation purposes. Hörmann can provide you with an attractive and appropriate solution for any fitting situation.



These Hörmann standard sizes will save you money and get you using your new sectional door faster.

Modernise with inexpensive and quickly available standard sizes

Hörmann offers many standard sizes that can easily be installed into your existing garage opening. Most of Hörmann's modernisation sizes are available directly from stock and therefore get to you quickly. Of course, we can also easily provide you with any required special solutions.

Everything from a single source with your Hörmann partner

Your Hörmann service partner can make modernisation easier than you think: from personal consultation to proper disassembly and environmentally-friendly disposal of your old door, as well as correctly dimensioned fitting.



Your Hörmann partners will gladly explain the benefits of a sectional garage door.

Trouble-free, simple fitting

For standard fitting, Hörmann delivers the sectional doors with all necessary fitting material. For problematic fitting situations, Hörmann has developed a special universal anchor that can be used to fasten the frame on the sides. The design flexibly compensates for any irregularities in the walls.

Clean bottom door edge for an attractive appearance

Hörmann offers attractive solutions for every fitting situation. This saves fitting time and reduces costs. Visible gaps between frames and the reveal can thus be covered with a frame covering, an optional retrofit fascia or a fascia frame set. Of course, all this comes in surface finishes and colours that match the door.



Your door is fitted within a day with an optional operator and convenient remote control.

On the following pages you will find numerous solutions for every fitting situation.

Properly mounted and fitted

Standard fitting and special anchors for side fixing



Everything standard

The sectional door can be fitted behind the opening. The reveal guarantees stable fitting. This allows the frame to be screwed directly into the wall behind the opening.

Standard fitting

Ideally, the available garage has at least 100 mm of clearance in the lintel area (at least 115 mm for doors with operators) and a 90 mm sideroom.

Hörmann sectional doors come with all the necessary fitting materials for this situation.



Optional special anchor for frame side fixing

The sectional door frame can be fitted to the side wall of the garage with Hörmann's special universal anchors. Irregularities in the wall can be easily compensated, leaving the reveal intact.

[1] Fitting with up to 35 mm wall spacing

[2] Fitting with angled or irregular side wall

[3] Fitting with non-load bearing facades (facing brick or thermal insulation) with at least 90 mm / 125 mm sideroom



For further information, please see the fitting data or contact your Hörmann partner.

Properly adjusted

Fascia panels to create the look of a single unit



Fascia panels

For standard fitting behind the opening with small lintel space

For all door versions, our standard fascia panels always match the door surface finish and colour or style and can thus be visibly mounted in the opening.



Double-skinned fascia panel

For fitting in the opening with larger gap to the ceiling

A matching, double-skinned additional fascia panel covers the gap between the ceiling and fascia panel. It is available for all surface finishes and colours or designs.



Flush-fitting fascia panels

For LPU doors, a fascia panel is the most elegant solution for an invisible transition between the panel and door leaf. When the door is closed, the top door section is flush with the panel. It is available for all door styles with all surface finishes and colours or designs (panelled on request).

For further information, please see the fitting data or contact your Hörmann partner.

Overall harmonious appearance

Frame covering and fascia frame set

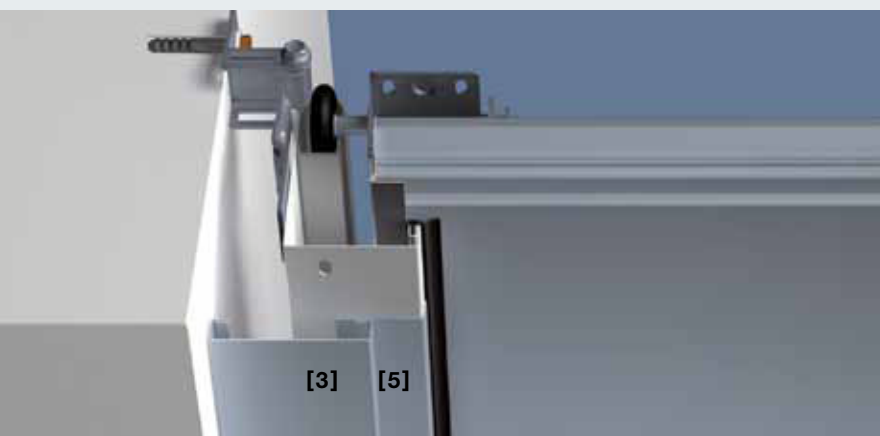
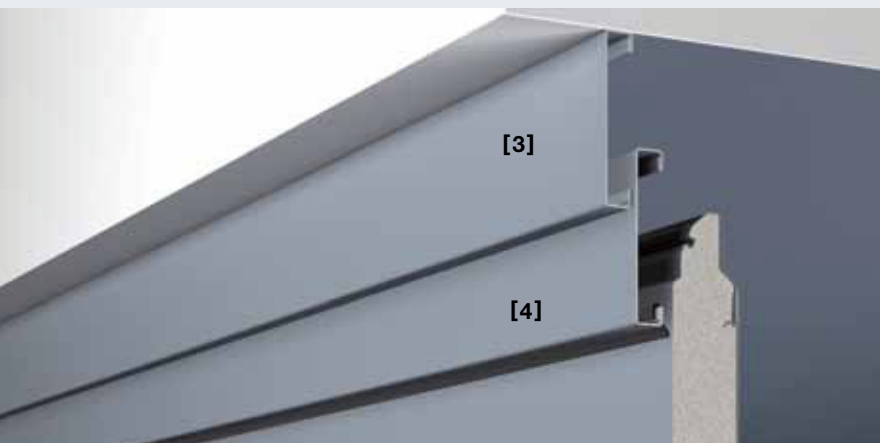
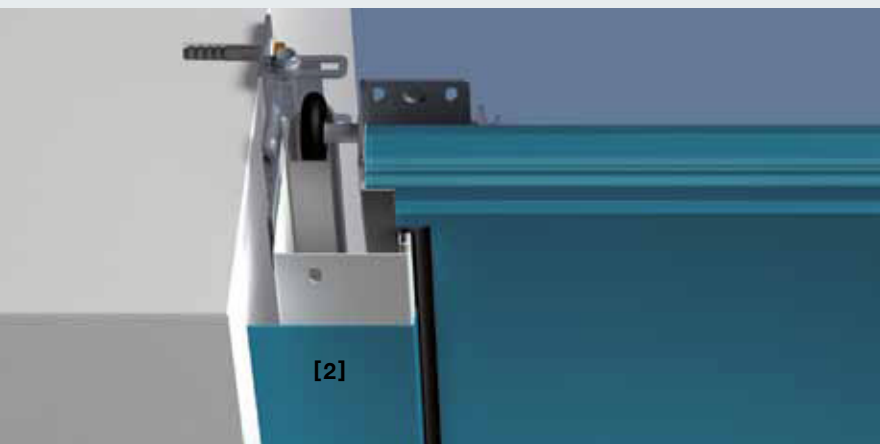
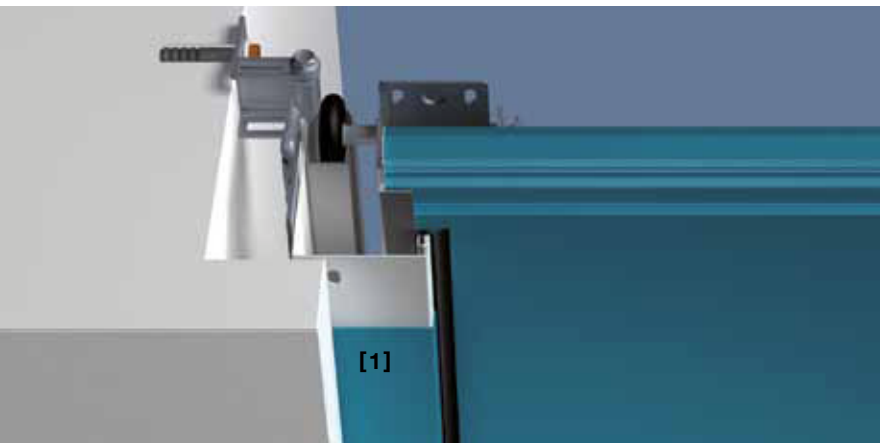

Frame covering in the colour of the door

At Hörmann, side frames are delivered in Woodgrain white as standard. With a frame covering that matches the door sections' surface finish and colour or decor, you can also achieve a harmonious appearance for sectional doors with Sandgrain, Micrograin, Silkgrain or Decograin surface finishes. For Micrograin doors, the frame covering is delivered with a smooth surface finish.

Two different widths make it possible to cover the side frame for different fitting situations.

[1] 55-mm-wide frame covering for fitting behind the opening, with little sideroom (< 90 mm)

[2] 90-mm-wide frame covering for fitting in the opening, flush with the wall

Fascia frame set for lintel and side

A door in an inexpensive standard or modernisation size can be fitted in the opening. The remaining gap between the side wall and door frame (max. 35 mm) is covered using a fascia frame set **[3]**. This set comes with fascia panels in the surface finish and colour or design of the door sections, end caps and fixing materials. For Micrograin doors, the frame covering comes with a smooth surface finish.

The fascia panels **[4]** match the surface finish and colour or decor of the door as standard. Additionally, the side frame is covered with a frame covering **[5]** in the surface finish and colour or decor of the door sections.

For further information, please see the fitting data or contact your Hörmann partner.

Solutions for special fitting situations

Retrofit fascias



Retrofit fascia set

To properly cover damaged wall edges

Unattractive gaps in the lintel and opening areas can be covered easily with the optional retrofit fascia, doing away with the need for additional bricklaying and plastering work.

The set with 3 fascia panels (each 3 metres long) is available in all surface finishes and colours or decors to match the door. For Micrograin doors, the fascia panel is delivered with a smooth surface finish.



Overall solution for sectional doors in concrete pre-fabricated garages

Broader fascia panels [1] for fitting in concrete pre-fabricated garages perfectly cover the lintel area of the opening.

The special door frame [2] with pre-fitted anchors and frame fascias is fitted to the side wall or on the conical sideroom. The wide frame fascia covers the existing gap between the frame and the opening.

This door version is available in the surface finishes Woodgrain and Silkgrain in all colours.



For further information, please see the fitting data or contact your Hörmann partner.

Hörmann's high-quality garage door operators
Reliable, safe and maintenance-free



Hörmann operator technology
Sophisticated and innovative technology that makes your life more convenient and safe.



**Garage door and entrance gate operators:
Everything perfectly matched from a single source**

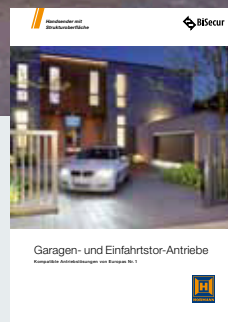

More information can be found
in the Garage Door and Entrance
Gate Operators brochure.

Two operator variants

Security both day and night with automatic locking



SupraMatic

The supra-fast operator with many additional functions.



SupraMatic as standard with hand transmitter HS 5 BS in black structure with chrome caps



ProMatic

The good-value starter model as an introduction to Hörmann's premium quality



ProMatic and ProMatic Akku as standard with hand transmitter HSE 2 BS in black structure with synthetic caps

ProMatic Akku
The optional solar module handles the battery recharge.



SupraMatic

- 5-button hand transmitter HS 5 BS (black textured surface) including querying the door position
- Low power consumption costing only around €3 per year**
- Extremely easy programming thanks to 2x 7-segment display
- Halogen lighting can be switched on/off separately
- Additional opening height for a well-ventilated garage
- Operator cover made of brushed aluminium

SupraMatic E

Pull and push force: 650 N
Peak force: 800 N
Opening speed: max. 22 cm/s
Door width: up to 5500 mm (max. 13.75 m² door surface)

SupraMatic P

incl. photocell
Pull and push force: 750 N
Peak force: 1000 N
Opening speed: max. 22 cm/s
Door width: up to 6000 mm (max. 15 m² door surface)
For heavy timber doors and doors with wicket doors

ProMatic

- 2-button hand transmitter HSE 2 BS (black textured surface)
- Additional opening height for a well-ventilated garage

ProMatic

Pull and push force: 600 N
Peak force: 750 N
Opening speed: max. 14 cm/s
Door width: up to 5000 mm (max. 11 m² door surface)

ProMatic Akku

For garages without power connection
Pull and push force: 350 N
Peak force: 400 N
Opening speed: max. 13 cm/s
Door width: up to 3000 mm (max. 8 m² door surface)

* The complete warranty conditions can be found at: www.hoermann.com

** For 5 door cycles per day and an electricity tariff of 0.25 Euros/kWh



Only from Hörmann

Automatic door locking

The door automatically locks on closing, making it impossible to lever it open. This unique automatic latching system is a mechanical device and therefore remains fully functional even in the event of a power failure.

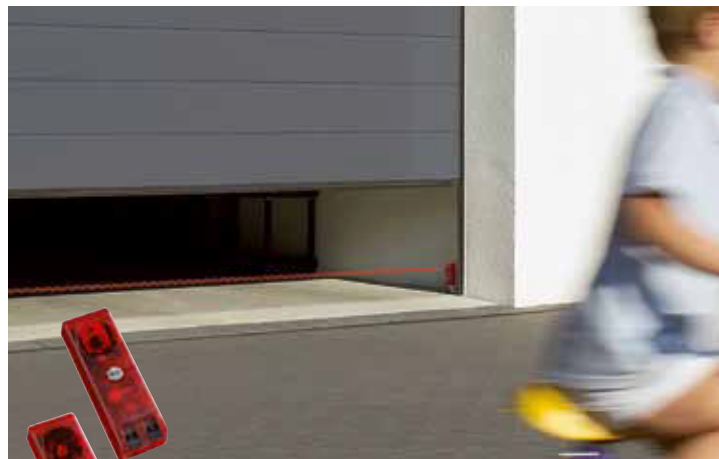

Photocell EL 101

Increased security

Families with children particularly appreciate extra safety. A photocell installed in the garage opening immediately stops the door before it encounters an obstruction. An extra bit of protection for a minimal cost.

Mobile radio accessories

For every situation



**Hand transmitter
HS 5 BS**
4 button functions
plus query button,
[1] High-gloss black or white
[2] Black textured surface **// NEW**

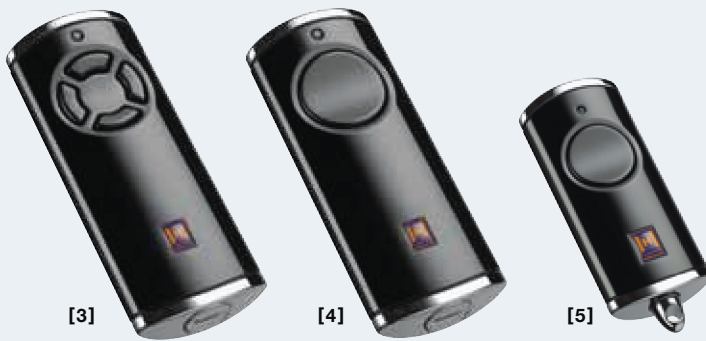

**Hand transmitter
HS 4 BS**
4 button functions,
[3] high-gloss black

**Hand transmitter
HS 1 BS**
1 button function,
[4] high-gloss black

**Hand transmitter
HSE 1 BS // NEW**
1 button function,
incl. eyelet for key ring
[5] High-gloss black



**Hand transmitter
HSE 2 BS**
2 button functions
incl. eyelet for key ring
[6] High-gloss black or white
[7] High-gloss green, purple,
yellow, red, orange
(figs. from left)

[8] Black textured surface with
chrome or plastic caps **// NEW**
[9] Decors in silver, carbon,
light rootwood, light timber,
dark timber, dark rootwood
(figs. from left)





reddot design award
honourable mention 2011



**Hand transmitter
HSD 2-A BS**
Aluminium look,
2 button functions,
can also be used as a key ring

HSD 2-C BS
High-gloss chrome,
2 button functions,
can also be used as a key ring



**Hand transmitter
HSP 4 BS**
4 button functions,
with button lock-out,
incl. key ring



**Hand transmitter
HSZ 1 BS**
1 button function,
for insertion in vehicle
cigarette lighter

HSZ 2 BS
2 button functions,
for insertion in vehicle
cigarette lighter



Hörmann Gateway and BiSecur app // NEW

With this app, you can conveniently control your Hörmann garage door and entrance gate operators, Hörmann entrance door* and other devices using your smartphone or tablet. You can also display the door position for your garage door or entrance gate, as well as the locking state of your entrance door* while on the go.

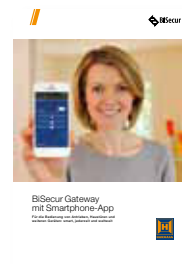

For further information, see the BiSecur Gateway brochure.

* With special equipment



HSZ hand transmitter

The alternative to homelink systems: integrated in an inconspicuous spot in your car. Inserted in the vehicle's cigarette lighter, the HSZ hand transmitter is easily accessible and convenient to operate.

Stationary radio accessories



**Radio code switch
FCT 3 BS**
For 3 functions,
with illuminated buttons



**Internal push button
IT 1b**
You can conveniently open
the door by pushing the large,
illuminated button on the IT 1b
(for ProMatic and SupraMatic).



**Radio code switch
FCT 10 BS**
For 10 functions,
with illuminated buttons
and protective cover



**Internal push button
IT 3b**
Along with a large illuminated
button for conveniently opening
the door, the internal push
button IT 3b has two additional
buttons.
These can be used to control
the operator light and
completely switch off the radio-
control system for the operator,
e.g. while you are away
on holiday (for SupraMatic).



**Radio finger-scan
FFL 12 BS**
For 2 functions
and up to 12 fingerprints

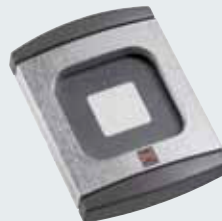

**Transponder key switch
TTR 100 / TTR 1000**
For 1 function,
with 2 keys (more on request)
for up to 12/100/1000 keys.



**Radio internal push button
FIT 2**
For 2 operators
or operator functions



**Key switch
STUP 40 / STAP 40**
In recessed and surface-
mounted versions,
including 3 keys



**Code switch
CTV 1 / CTV 3**
For 1 or 3 functions,
especially robust,
protected against vandalism



With Hörmann, everything fits together. Using the same hand transmitter, you can operate your garage door as well as your Hörmann entrance gate operator.



**Photocell
EL 101**

Hörmann's reliable one-way photocell systems immediately stop the gate if the light beam is interrupted.



**Emergency battery HNA
for garage door operators**

With this emergency power supply, you can bypass network power failures for up to 18 hours and max. 5 door cycles. The emergency battery recharges itself during normal operation. Emergency batteries can be added to all current Hörmann garage door operators.



Light key switch post SLS

The light key switch post SLS with an LED light module is available in heights of 550 mm and 1080 mm. For even better illumination of your entrance area, the 1080 mm key switch post is also available with two LED light modules.

SLS-K
with LED light module
Height 550 mm

SLS-L
with double LED module
Height 1080 mm

SLS-L
with LED light module
and design screen
Height 1080 mm

Energy efficiency class A



Design
screen

Warm
white light

Neutral
white light

LED light modules

You can choose between a warm or neutral white light in the light modules. The optional aluminium design screen creates a special accent.



LED lighting for doors

An LED light strip with neutral white light puts your door and side door in the right light. The plug-in system can be shortened individually, making it a perfect fit for any door width. You can choose whether to mount the LED light strip on the lintel (see above fig.) or on the bottom edge of the door leaf.

LED distance: 125 mm

Energy efficiency class A

Technically mature

Operating comfort with the highest security



Safety while operating the garage door is top priority for Hörmann. And Hörmann sets the standards for this with its innovative solutions. This has been proven time and time again through numerous Hörmann patents.

And this provides you and your family with safety during daily use.



Safety features in accordance with European standard 13241-1

Anti-fall safeguard/trap protection

Hörmann sectional doors are tested and certified in accordance with the high safety requirements of European standard 13241-1, not only on their own but also in combination with operators. It would be hard to find a safer sectional door.

It pays to compare!



Hörmann patent

Tension spring assembly with spring-in-spring system

Hörmann sectional doors with double tension springs and double cables per side safeguard the door leaf against crashing to the floor. Thanks to the patented spring-in-spring system, broken springs are prevented from flying out and causing injuries.

Sectional doors up to 3000 mm wide and 2625 mm high include the proven tension spring technology as standard.



Hörmann patent

Torsion spring assembly with integrated spring safety device

Hörmann sectional doors incorporate torsion springs on both sides featuring a patented spring safety device. In the event of a spring breaking, they arrest the door immediately, thereby preventing the door leaf from crashing to the floor. Larger sectional doors and doors with integral wicket door or garage doors with solid timber panels feature torsion spring technology.



Hörmann patent

Secure guidance of the door in safety tracks

Adjustable, patented track rollers, sturdy roller holders and safety tracks ensure that there is no danger of the door "derailing". The door sections are safely parked under the ceiling.



Finger trap protection on the inside, outside and on the hinges

The unique form of the door sections eliminates trap points, both between the sections and on the hinges. This reliable finger trap protection is only offered by Hörmann.



Trap guard on the side frame

With Hörmann, the frames are completely closed from top to bottom. There are no gaps between the door leaf and frame in which fingers could get trapped!

Optimum thermal insulation

Tested and certified

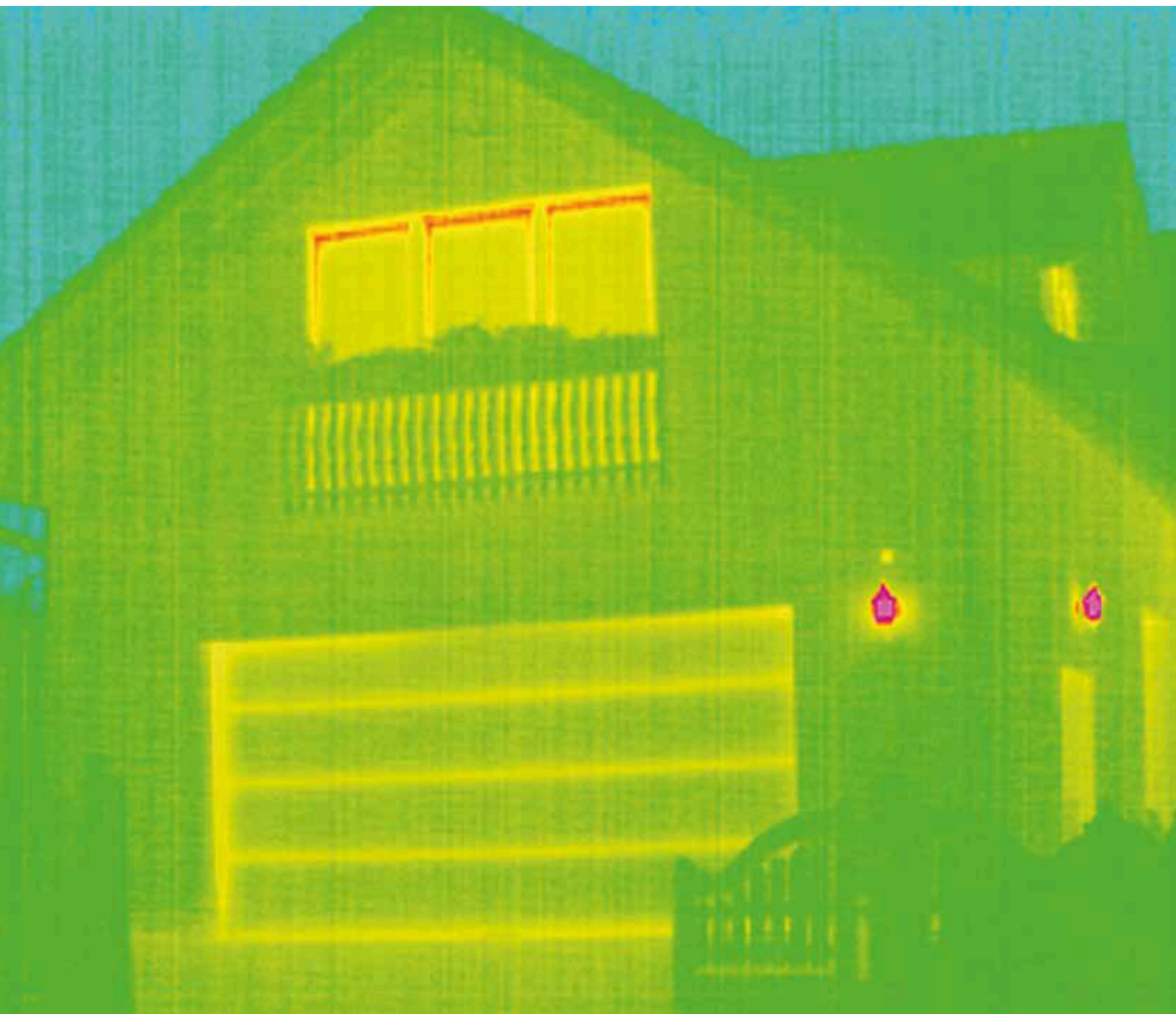

A well-insulated garage door is always recommended when the garage and the home are directly connected. The ThermoFrame frame connection further improves the already high insulation values of the double-skinned Hörmann sectional garage doors.

This reduces your energy costs.



ThermoFrame Improved thermal insulation for sectional doors

The plastic profile that can be simply fitted together with the door frame, creates a thermal break between the frame and the brickwork, improving the thermal insulation by up to 15 %*.

In addition, extra lip seals on both sides and in the upper section of the door provide better sealing while lowering the loss of heating energy from the garage interior.

The ThermoFrame frame connection is optionally available for all Hörmann sectional garage doors.



Performance characteristics according to European standard 13241-1

At Hörmann, the four important characteristics of thermal insulation, acoustic insulation, tightness and sealing, and wind load for garage doors are tested and certified.

Thermal insulation

Single-skinned steel sectional door LTE		
Door leaf		U = 2.5 W/(m ² ·K)
Fitted door ¹⁾		U = 3.0 W/(m ² ·K)
Double-skinned steel sectional door LPU		
Section		U = 0.5 W/(m ² ·K)
Door leaf		U = 0.9 W/(m ² ·K)
Fitted door ¹⁾		U = 1.4 W/(m ² ·K)
Sectional doors with solid wood panels LTH		
Door leaf		U = 2.5 W/(m ² ·K)
Fitted door ¹⁾		U = 3.0 W/(m ² ·K)

Acoustic insulation

Single-skinned steel sectional door LTE	R = approx. 20 dB
Double-skinned steel sectional door LPU	R = approx. 25 dB

Sealing

Air	Single-skinned steel sectional door LTE	Class 0 ²⁾
	Double-skinned steel sectional door LPU ribbed (not L-ribbed)	Class 2
	Double-skinned steel sectional door LPU panelled and L-ribbed	Class 3
	Sectional doors with solid wood panels LTH	Class 0 ²⁾
Water	Single-skinned steel sectional door LTE	Class 0 ²⁾
	Double-skinned steel sectional door LPU	Class 3 ³⁾
	Sectional doors with solid wood panels LTH	Class 0 ²⁾

Wind load

Single-skinned steel sectional door LTE	Class 2
Double-skinned steel sectional door LPU	Class 3
Sectional doors with solid wood panels LTH	Class 3

Higher wind load classes on request

* For a double-skinned sectional garage door LPU size 5000 × 2125 mm

¹⁾ The U-values apply to fitted doors without glazing in the size: 5000 × 2125 mm

²⁾ Doors with ventilation slots, on request classes 2 – 3

³⁾ Up to 70 Pa water pressure

Track applications

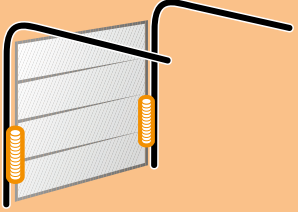
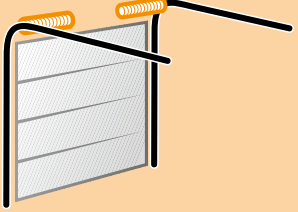
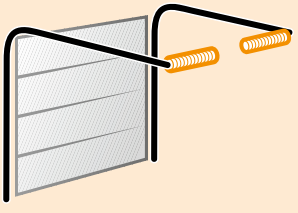
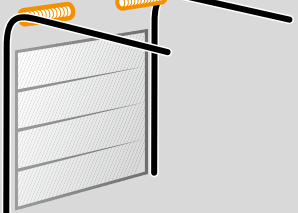
	<p>Track application Z</p> <p>Tension spring track application with torsion spring technology Max. width 3000 mm Max. height 2625 mm</p>
	<p>Track application N</p> <p>Normal track application with torsion spring technology Max. width 6000 mm Max. height 3000 mm</p>
	<p>Track application L</p> <p>Low-headroom tracks with torsion spring technology Max. width 6000 mm Max. height 3000 mm</p>
	<p>Track application H</p> <p>High-lift track application with torsion spring technology Max. width 5500 mm Max. height 3000 mm</p>

Explanations

If you are interested in this track version for high-lift doors, contact your Hörmann specialist dealer.

Timber doors are not generally supplied with Z tracks.

LZ Clear frame dimensions
 RM Grid height

DE Ceiling height
Track application N:
 ** With ThermoFrame and operator + 45 mm
Track application Z / L:
 ** With ThermoFrame and operator + 30 mm

LDH Clear passage height
Track application L:
 * With doors over 3010 mm wide, the clear passage is reduced by a further 50 mm.

GIM Inside garage dimension
 ET Distance back

For further information, please see the fitting data or contact your Hörmann partner.

Dimensions and fitting data

Track applications and fitting dimensions LPU, LTE

Horizontal view

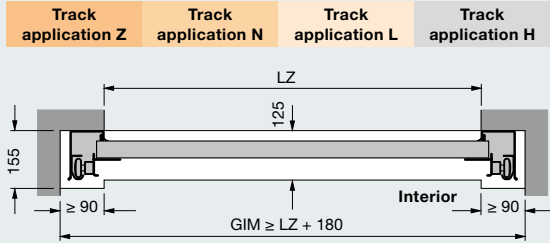

Fitting with track applications Z, N, L

Overall length operators	Track application Z	Track application N	Track application L
Doors with operator			
2125 (K)	3200		3200
2250 (K)		3200	
2375 (M)	3450		3450
2500 (M)		3450	
3000 (L)	4125	4125	4125

Vertical views

Track application Z

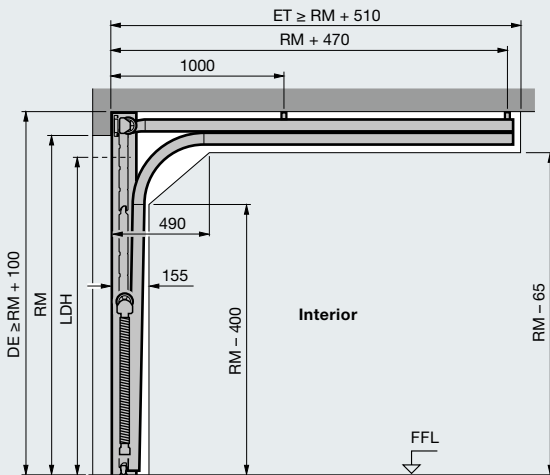

Track application N

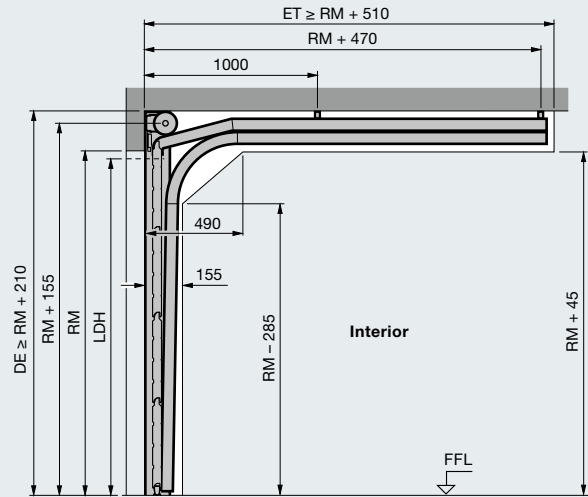

Track application L

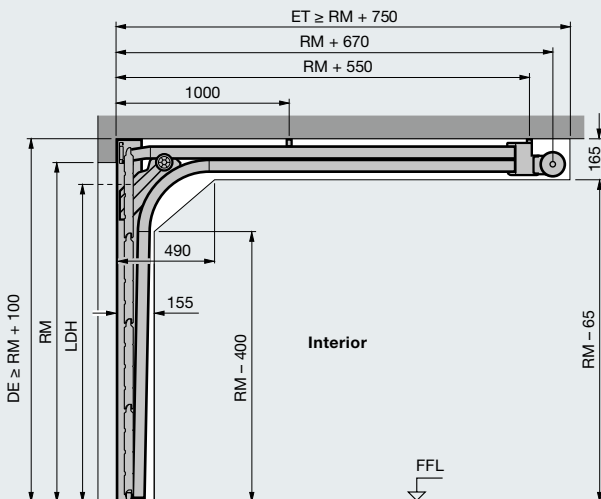

Track application H

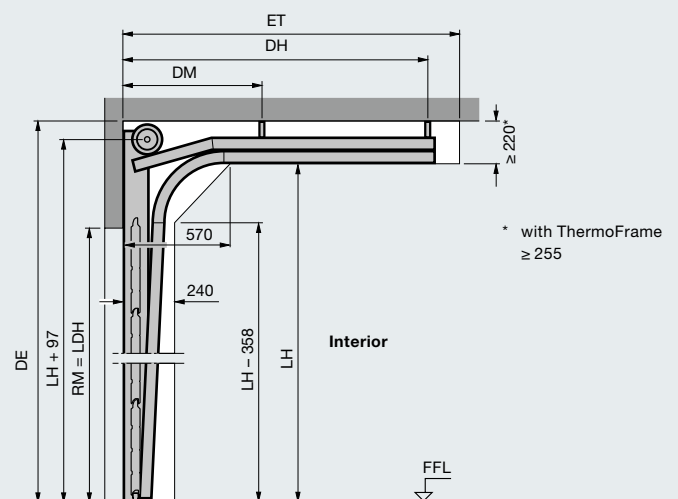

Fitting with flush-fitting panel

Overall length operators	Track application BZ	Track application BL
Doors with operator		
	2125 (K)	3272
Door height up to	2375 (M)	3522
	3000 (L)	4197

Vertical views

Track application BZ Track application BL Without lintel

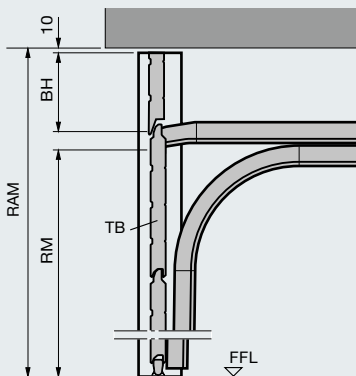

Track application BZ Track application BL With lintel

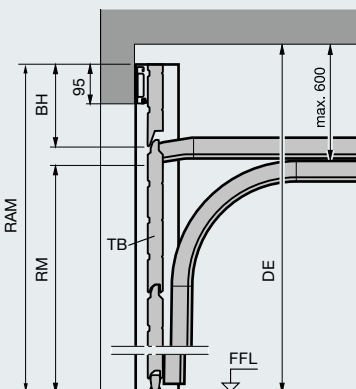

Explanations

- Drive booms**
- K Short boom
 - M Medium boom
 - L Long boom
- Track applications**
- Z Tension spring track application
 - N Normal track application
 - L Low headroom track application
 - H High-lift track application
- If you are interested in this track version for high-lift doors, contact your Hörmann specialist dealer.
- BZ Tension spring track application with flush-fitting panels
 - BL Low-lintel track application with flush-fitting panels
- Ordering sizes**
- LZ Clear frame dimensions
 - RM Grid height
 - RAM Overall frame dimension (of flush-fitting panels)
 - Min. = RM + 240 mm
 - Max. = RM + 600 mm (door section height)
- DE Ceiling height
- Track application N:**
- Manual operation \geq RM + 210 mm
 - With operator \geq RM + 210 mm
 - With operator and ThermoFrame \geq RM + 255 mm
- Track application Z / L:**
- Manual operation \geq RM + 100 mm
 - With operator \geq RM + 115 mm
 - With operator and ThermoFrame \geq RM + 145 mm
- LDH Clear passage height
- Track application N:**
- Manual operation = RM - 50 mm
 - With operator = RM
- Track application Z / BZ:**
- Manual operation = RM - 80 mm
 - With operator = RM - 30 mm
- Track application L / BL:**
- Manual operation = RM - 100 mm
 - With operator (LZ < 3000) = RM - 30 mm
 - With operator (LZ > 3000) = RM - 80 mm
- GIM Inside garage dimension
 - ET Distance back
 - TB Door leaf
 - BH Panel height
 - LH Track height
 - DM Ceiling suspension, centre
 - DH Ceiling suspension, back
 - FFL Finished floor level

Note

Before fitting a sectional door, the structural openings must be finished and the floors be laid and level. The clearance required for fitting the door must be free of supply lines, heater fans, etc.

For further information, please see the fitting data or contact your Hörmann partner.

Dimensions and fitting data

LPU with wicket door with trip-free threshold

○ = Not possible with Decograin, Micrograin Sandgrain and Silkgrain
 □ = Not possible with Decograin

Size range for ribbed doors with wicket doors

		LPU doors with wicket doors								
Door height grid (RM)	3000									
	2875	○	○	○	○	○	○	○	○	○
	2750									
	2625	○	○	○	○	○	○	○	○	○
	2500									
	2375									
	2250									
	2205									
	2125									
	2080									
	2000									
	1955									
	1875									
			2250	2375	2500	2750	3000	3250	3500	3750
		Door width grid (LZ)								

Ribbed wicket doors: clear passage height and lever height

Wicket doors without glazing	Wicket doors with glazing	Lever height from FFL
1955	1955	831
1871	1871	799
2155	2155	906
2055	2055	868
1955	1955	831
1855	1855	793
2123	2203	924
2075	2155	906
1999	2079	877
1955	2035	861
1875	1955	831
1827	1907	813
1747	1827	782

Size range for panelled doors with wicket doors

		LPU doors with wicket doors								
Door height grid (RM)	3000									
	2875	□	□	□	□	□	□	□	□	□
	2750	□	□	□	□	□	□	□	□	□
	2625	□	□	□	□	□	□	□	□	□
	2500									
	2375									
	2250									
	2205	□	□	□	□	□	□	□	□	□
	2125									
	2080	□	□	□	□	□	□	□	□	□
	2000									
	1955	□	□	□	□	□	□	□	□	□
	1875									
			2250	2500	2750	3000	3250	3500	3750	4000
		Door width grid (LZ)								

Panelled wicket doors: clear passage height and lever height

Wicket doors	Lever height from FFL
1955	831
1871	799
2155	906
2055	868
1955	831
1855	793
2203	924
2155	906
2079	877
2035	861
1955	831
1907	813
1827	782

Horizontal view

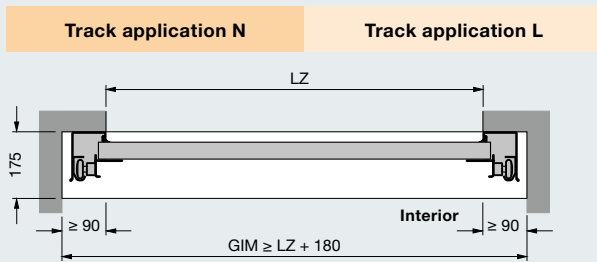

Vertical views

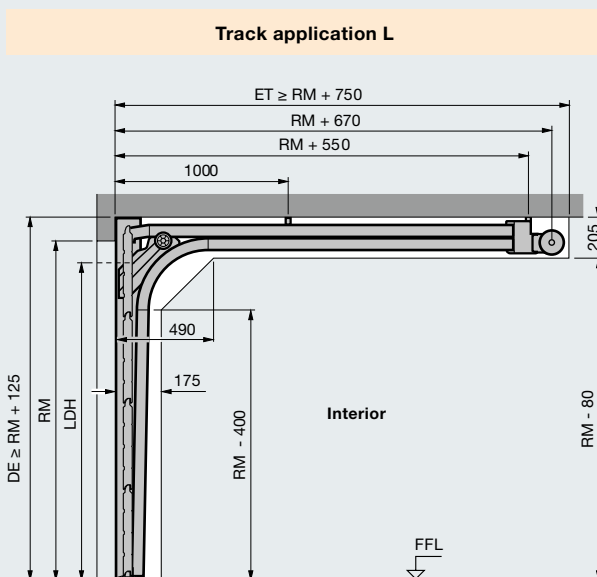
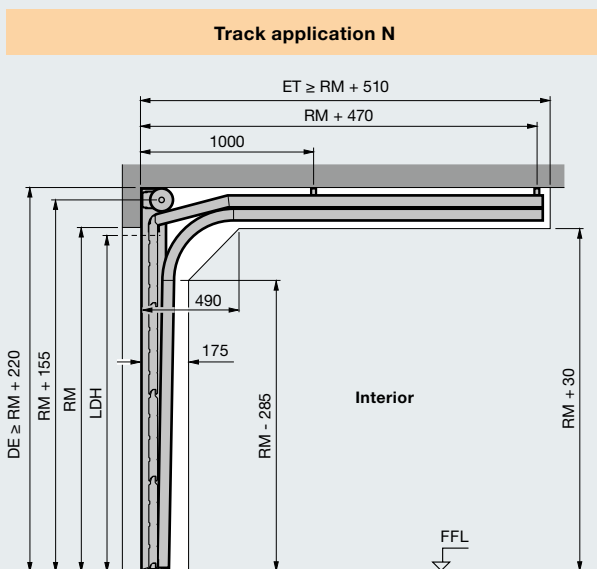

Explanation of dimensions

Track applications
 N Normal track application
 L Low headroom track application

Ordering sizes
 LZ Clear frame dimensions
 RM Grid height

DE Ceiling height
Track application N:
 Manual operation $\geq RM + 220$ mm
 With operator $\geq RM + 235$ mm
 With operator and ThermoFrame $\geq RM + 255$ mm
Track application L:
 Manual operation $\geq RM + 125$ mm
 With operator $\geq RM + 125$ mm
 With operator and ThermoFrame $\geq RM + 145$ mm

LDH Clear passage height
Track application N:
 Manual operation = $RM - 160$ mm
 With operator = $RM - 100$ mm
Track application L:
 Manual operation = $RM - 160$ mm
 With operator = $RM - 160$ mm

GIM Inside garage dimension
ET Distance back
FFL Finished floor level

Note
 The opening height must not be less than the ordering size of the garage door (RM), otherwise the wicket door will not open.

Fitting with ThermoFrame

When fitting with ThermoFrame
 $LDB = LZ - 12$ mm
 When fitting with ThermoFrame and frame covering
 $LDB = LZ - 15$ mm
 When fitting with ThermoFrame and operator
 Track application N + 20 mm
 Track application L + 20 mm

Dimensions and fitting data

Steel and solid timber side doors

Horizontal views

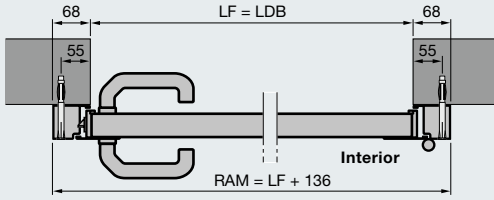

Side door with aluminium block frame, profile type 1
Fitting behind the opening

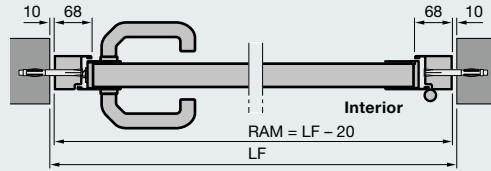

Side door with aluminium block frame, profile type 2
Fitting in the opening

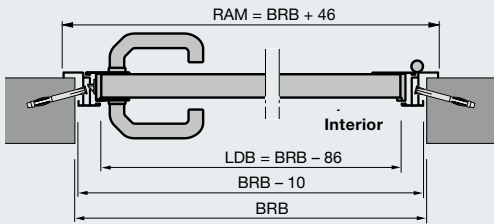

Side door with aluminium corner frame, profile type 3
External fitting

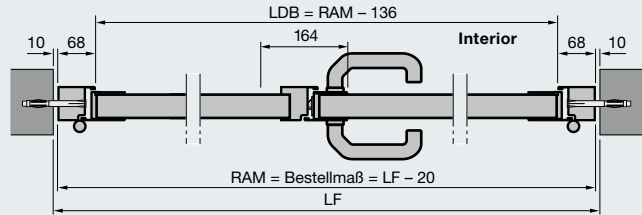

Double-leaf side door with aluminium block frame, profile type 2
Fitting in the opening

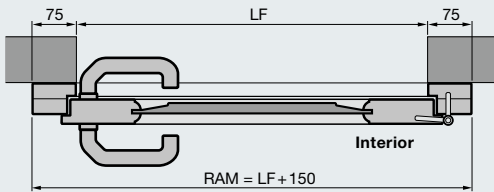

Solid timber side door
Fitting behind the opening

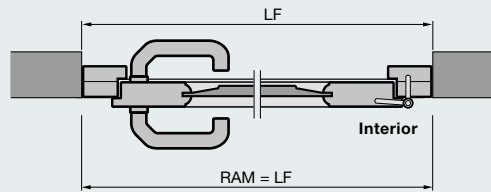

Solid timber side door
Fitting in the opening

Vertical views

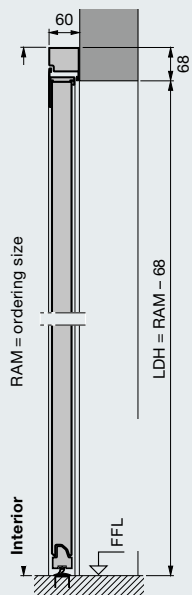

Side door with aluminium block frame, profile type 2
Fitting behind the opening



Side door with aluminium block frame, profile type 2
Fitting in the opening

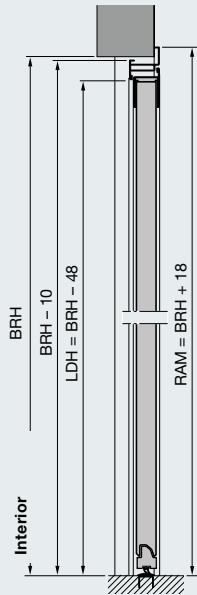

Side door with aluminium corner frame, profile type 2
External fitting

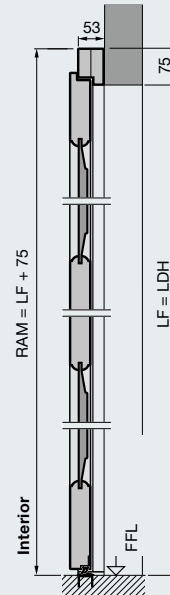

Solid timber side door
Fitting behind the opening

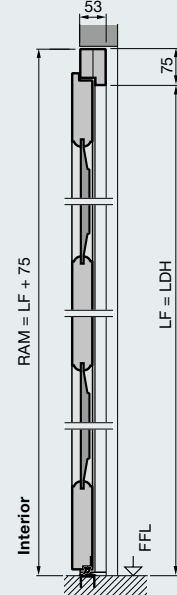

Solid timber side door
Fitting in the opening

Standard sizes, steel side doors

Ordering size = RAM	Structural opening	Lever height*		
		P1	P2	P3

Block frame, fitting behind the opening (ordering size = overall frame dimension) Profile type 1 (only opening inwards) and profile type 2

Ordering size = RAM	Structural opening	P1	P2	P3
990 × 2058	855 – 875 × 1990 – 2000	955	1050	
990 × 2183	855 – 875 × 2115 – 2125	1010	1050	
1115 × 2058	980 – 1000 × 1990 – 2000	955	1050	
1115 × 2183	980 – 1000 × 2115 – 2125	1010	1050	

Block frame, fitting in the opening (ordering size = overall frame dimension) Profile type 2 (only S, M, L-ribbed)

Ordering size = RAM	Structural opening	P1	P2	P3
855 × 1990	875 × 2000		1050	
855 × 2115	875 × 2125		1050	
980 × 1990	1000 × 2000		1050	
980 × 2115	1000 × 2125		1050	

Corner frame, internal fitting (ordering size = BRB × BRM) Profile type 1 and profile type 2 (only S, M, L-ribbed)

Ordering size = RAM	Structural opening	P1	P2	P3
875 × 2000		955	1050	
875 × 2125		1010	1050	
1000 × 2000		955	1050	
1000 × 2125		1010	1050	

Corner frame, external fitting (ordering size = BRB × BRM) Profile type 2 (only S, M, L-ribbed) and profile type 3

Ordering size = RAM	Structural opening	P1	P2	P3
875 × 2000			1050	955
875 × 2125			1050	1010
1000 × 2000			1050	955
1000 × 2125			1050	1010

Standard sizes, solid timber side doors

Ordering size = RAM	Structural opening	Lever height*
---------------------	--------------------	---------------

Fitting behind the opening (ordering size = overall frame dimension) (S, M, L-ribbed, panelled)

Ordering size = RAM	Structural opening	Lever height*
1005 × 2190	855 – 875 × 2115 – 2125	1050
1130 × 2190	980 – 1000 × 2115 – 2125	1050

Fitting behind the opening (ordering size = overall frame dimension) (Styles 401, 403, 404, 405)

Ordering size = RAM	Structural opening	Lever height*
1130 × 2190	980 – 1000 × 2115 – 2125	1050

Explanations

P1 Profile type 1 (narrow surround)
P2 Profile type 2 (broad surround)
P3 Profile type 3 (narrow surround)

LDB Clear passage width
LDH Clear passage height
RAM Overall frame dimension
LF Structural opening
BRM Nominal size
BRB Nominal size - width
BRH Nominal size - height
FFL Finished floor level

Special sizes

Single-leaf side doors on request
Double-leaf side doors:
1200 – 2558 × 1960 – 2558

* You can find the lever heights for special sizes in the technical manual.



Experience Hörmann quality

For every application involving new construction and modernisation

Hörmann provides an excellent basis for comprehensive planning. Carefully matched solutions offer you the very best in perfectly designed products for every area.

Garage doors

Optimally match your personal architectural style: up-and-over or sectional doors made of steel or timber.

Door operators

Enjoy extra convenience and break-in-resistant security: Hörmann operators for garage doors and entrance gates.

Entrance doors

Our comprehensive entrance door ranges include models that fit almost every need and requirement.

Steel doors

Sturdy doors for your entire home, from basement to roof.

Frames

Choose from our comprehensive range of products for new construction, expansion and modernisation.



Garage doors and entrance gate operators



ThermoPro entrance door



Steel doors

www.hoermann.com

Hörmann: Quality without Compromise



Hörmann KG Amshausen, Germany



Hörmann KG Antriebstechnik, Germany



Hörmann KG Brandis, Germany



Hörmann KG Brockhagen, Germany



Hörmann KG Dissen, Germany



Hörmann KG Eckelhausen, Germany



Hörmann KG Freisen, Germany



Hörmann KG Ichttershausen, Germany



Hörmann KG Werne, Germany



Hörmann Genk NV, Belgium



Hörmann Alkmaar B.V., Netherlands



Hörmann Legnica Sp. z o.o., Poland



Hörmann Beijing, China



Hörmann Tianjin, China



Hörmann LLC, Montgomery IL, USA



Hörmann Flexon LLC, Burgettstown PA, USA

Hörmann is the only manufacturer worldwide that offers you a complete range of all major building products from one source. We manufacture in highly-specialised factories using the latest production technologies. The close-meshed network of sales and service companies throughout Europe, and activities in the USA and China, make Hörmann your strong partner for first-class building products, offering “Quality without Compromise”.

GARAGE DOORS
OPERATORS
INDUSTRIAL DOORS
LOADING EQUIPMENT
HINGED DOORS
DOOR FRAMES

